



RoHS Compliant

Illuminated Pushbutton - 22mm & 25mm

Specifications

Electrical Ratings	2A @ 24VDC 2A @ 125VAC 1A @ 250VAC
Sealing Degree	IP65
Electrical Life	50,000 cycles typical
Contact Resistance	≤ 50mΩ initial

Actuation Force	550 ±50gF
Actuation Travel	2.5 ± .3mm
Dielectric Strength	2000Vrms min contact to contact 2000Vrms min contact to LED
Insulation Resistance	≥ 100MΩ min
Operating Temperature	-25°C to 70°C
Storage Temperature	-25°C to 70°C

Materials

Actuator	Stainless Steel or Black Anodized Aluminum
LED Lens	Polycarbonate (PC)
Threaded Body	Stainless Steel or Black Anodized Aluminum
Terminal Support	Polybutylene Terephthalate (PBT)
Inner Switch Body	Polycarbonate (PC)
Contacts	Silver Alloy
Terminals	Brass, Epoxy Sealed
Hardware	One Hex Nut & One "O" Ring Supplied

DH

Illuminated Pushbutton - 22mm

Ordering Information

1. Series	DH22	1	N	B	S	R	Z	Z
	DH22 - 1 Pole only DH25 - 1 or 2 Pole							
2. Number of Poles	1 = SPST NO + SPST NC 2 = DPST NO + DPST NC **only available with DH25							
3. Latching Option	N = Momentary L = Latching							
4. Actuator Style:	A = Flush actuator, non-illuminated B = Flush actuator, ring illuminated C = Flush actuator, dot illuminated G = Flush actuator, international standby symbol illuminated							
5. Switch Finish	S = Stainless Steel B = Black Anodized Aluminum							
6. First LED Color	Z = No LED R = Red Y = Yellow G = Green B = Blue W = White O = Orange							
7. Second LED Color	Z = No LED R = Red Y = Yellow G = Green B = Blue O = Orange <small>**For bi-color LED option, White not available</small>							
8. LED Voltage	Z = No LED N = No internal resistor in series with the LED 6 = 6V 12 = 12V 24 = 24V 110 = 110V 220 = 220V							

Dimensions

22mm - Actuator Styles, available in Single Pole only

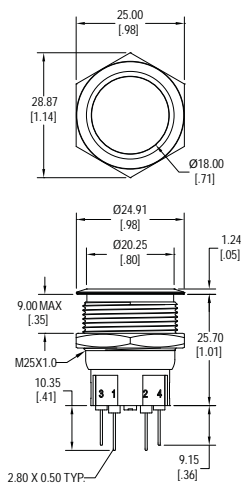

A Non-Latching

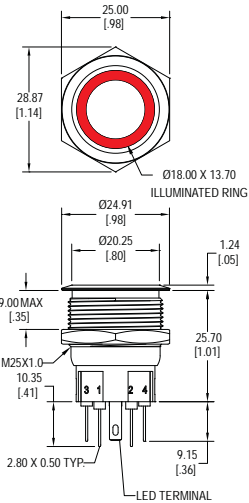

B Non-Latching

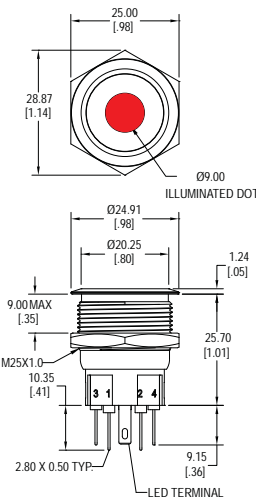

C Non-Latching

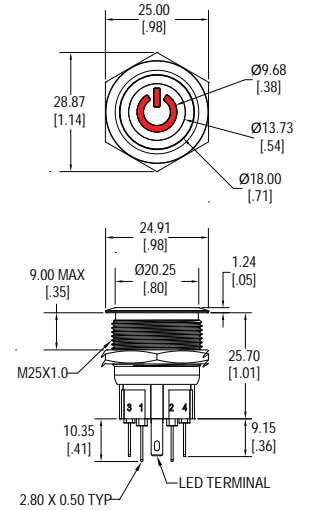

G Non-Latching

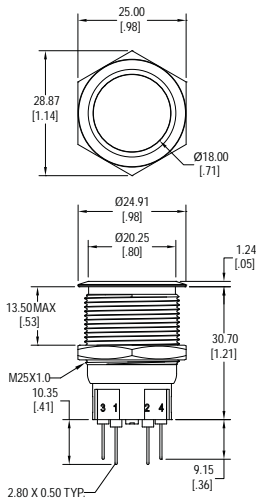

A Latching

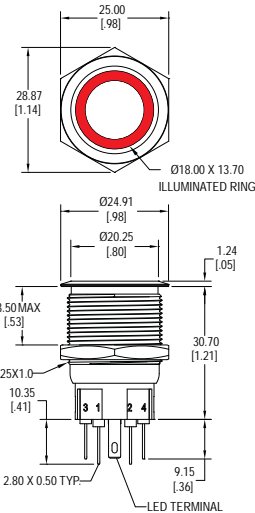

B Latching

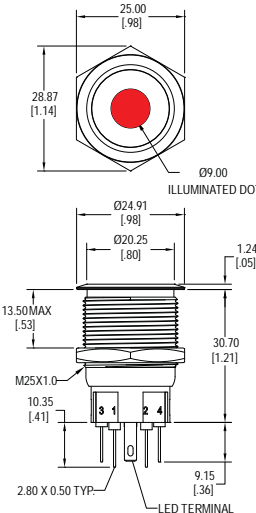

C Latching

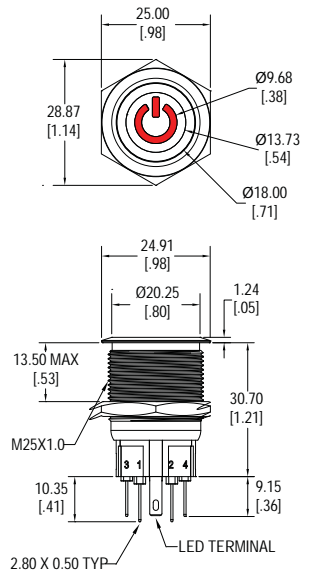

G Latching

Dimensions

25mm - Actuator Styles, available in Single Pole & Double Pole

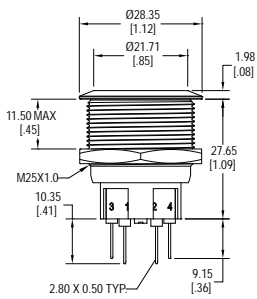
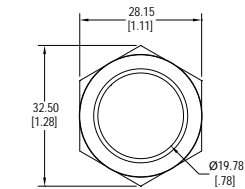

A Non-Latching

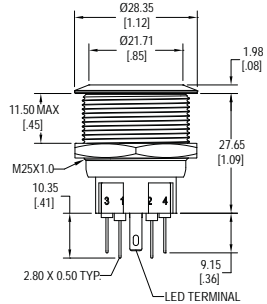
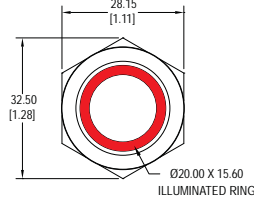

B Non-Latching

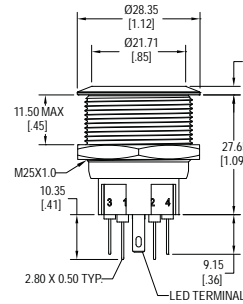
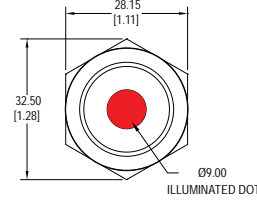

C Non-Latching

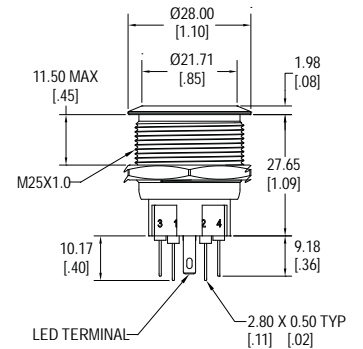
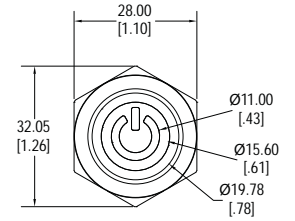

G Non-Latching

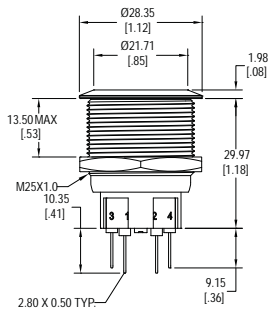
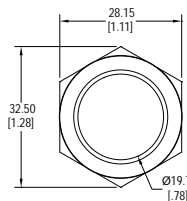

A Latching

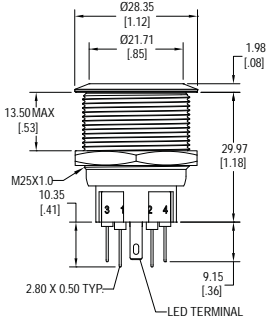
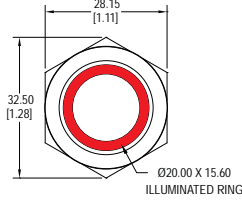

B Latching

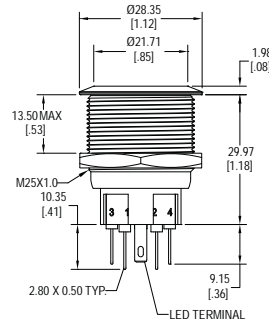
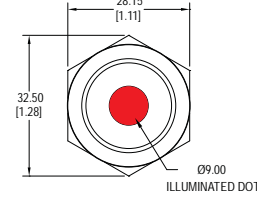

C Latching

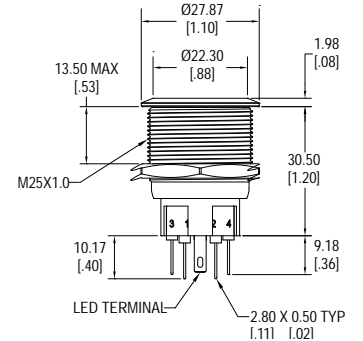
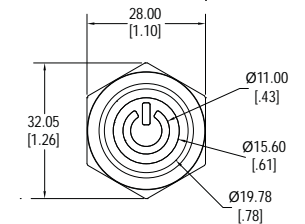

G Latching

Schematics

22mm - Actuator Styles, available in Single Pole

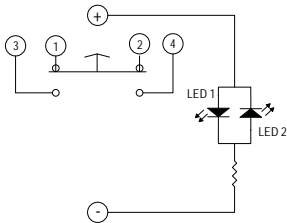

Schematic

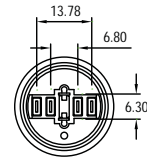

Bottom View

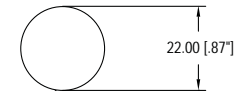

MAXIMUM PANEL THICKNESS = 9.50 [0.37"]

Panel Cut-Out

25mm - Actuator Styles, available in Single Pole & Double Pole

Single Pole

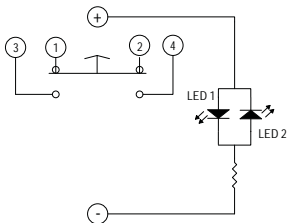

Schematic

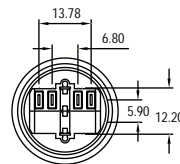

Bottom View

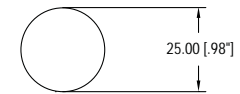

MAXIMUM PANEL THICKNESS = 11.50 [0.45"]

Panel Cut-Out

Double Pole

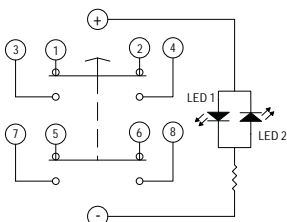

Schematic

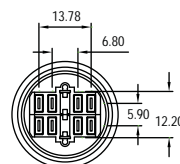

Bottom View

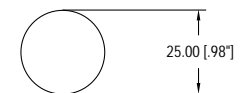

MAXIMUM PANEL THICKNESS = 11.50 [0.45"]

Panel Cut-Out

LED Characteristics

LED Ratings		Color						
		R	Y	G	B	O	W	Units
Reverse Voltage	V_R	5	5	5	5	5	5	V
Forward Current (peak)	I_{FS}	120	120	160	160	120	160	mA
Reverse Current $V_R = 5V$	I_R	10	10	10	10	10	10	μA
Power Dissipation	P_T	80	80	120	120	80	120	mW
Forward Voltage (typ) $I_F = 20mA$	V_F	2.1	2.1	3.3	3.3	2.0	3.0	V
Luminous Intensity, $I_F = 20mA$	LI	120	120	170	100	120	700	mcd