

**UL 1500 Ignition Proof.
High interrupt capacity.
Reliable on land or sea.**



Series 14.

Count on it.



Series 14 Overview

One of the newest members of the Mechanical Products family of circuit protectors is the Series 14.

The Series 14 is an economical and compact circuit protector designed for your equipment protection needs in the 3-20 amp range. The MP Series 14 is suitable for a variety of applications ranging from medical equipment to household appliances.

Series 14 offers:

5 unique termination options, multiple hardware and boot options, AC/DC ratings from 3 to 20 amps, UL 1500 Ignition Protection, UL, cUL, CSA, VDE & CCC certification, European RoHS Directive compliance, and a choice of snap-in or threaded mounting, with 9 button and 5 bushing options from which to select.

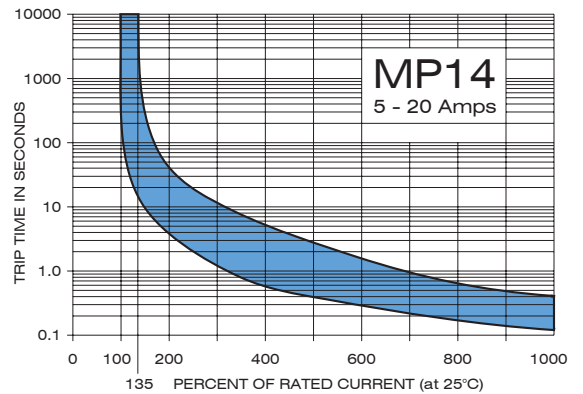
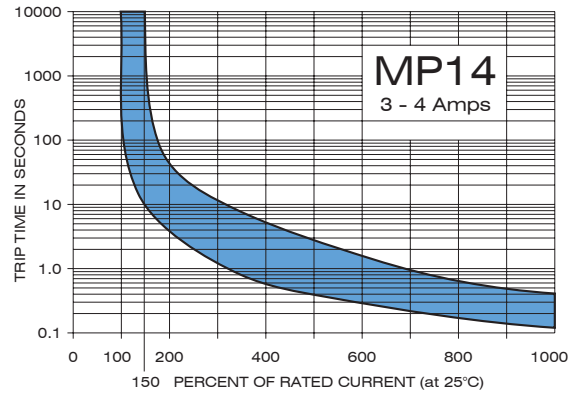

Series 14 Specifications

Standard Amp Ratings

Series 14 has available RoHS compliant current ratings of 3A, 4A, 5A, 6A, 7A, 7.5A, 8A, 10A, 12A, 13A, 14A, 15A, 16A, and 20A.

Minimum Ultimate Trip

The Series 14 offers a minimum ultimate trip of 100% of rated current at 25°C/77°F.

Interrupt/Voltage Ratings

Per UL, Series 14 is rated for 1000A at 250VAC/50VDC and 3000A at 32VDC.

Corrosion (Salt Spray)

The Series 14 conforms to 96hr, 5% salt mist, per IEC 60068-2-11, test Ka.

Regulatory Approvals

UL/cUL recognition per UL 1077 (E66224), CCC (2004010307103862), VDE per IEC 934 (40009272), CSA per C22.2-235 (027156), and UL 1500 for Ignition Protection.

Maximum Ultimate Trip

The Series 14 maximum ultimate trip is 135% of rated current for ratings of 5A and above and 150% below 5A, at 25°C/77°F.

Voltage Drop

The Series 14 has a maximum voltage drop of 0.25V at rated current.

Vibration and Shock

The Series 14 is vibration rated at 8g per IEC 60068-2-6, test Fc, and shock rated at 30g (11ms) per IEC 60068-2-27, test Ea.

Overload Trip Time Data (in seconds)

Current Rating	200%	300%	400%	500%	600%	800%	1000%
3 - 20 A	4-40	1.2-12	.6-5	.4-2.8	.3-1.8	.15-.6	.12-.4

Ambient Temperature Correction Factor

Current Rating	°F	23	32	68	77	86	104	122	140
	°C	-5	0	20	25	30	40	50	60
3 - 4 A		.72	.75	.90	1.00	1.10	1.25	1.61	2.15
5 - 6 A		.75	.80	.90	1.00	1.05	1.10	1.20	1.40
7 - 15 A		.80	.85	.95	1.00	1.05	1.15	1.25	1.40
16 - 20 A		.80	.85	.95	1.00	1.03	1.08	1.16	1.22

Series 14 Physical Configuration

Bushing Options

(See Part Numbering Guide)

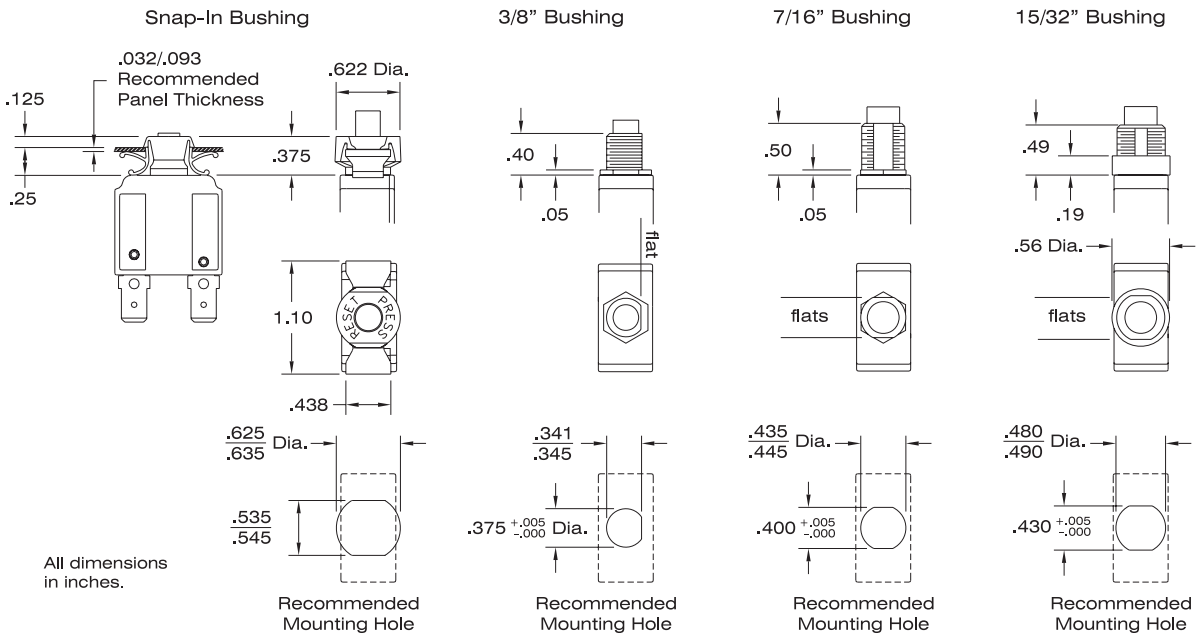

Terminal Options

(See Part Numbering Guide)

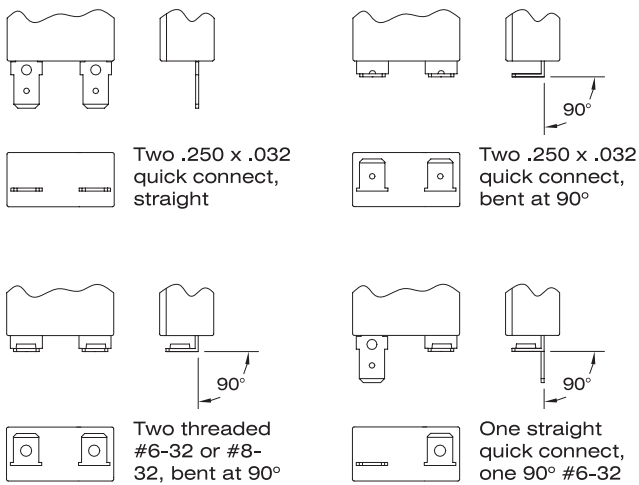

Envelope Dimensions

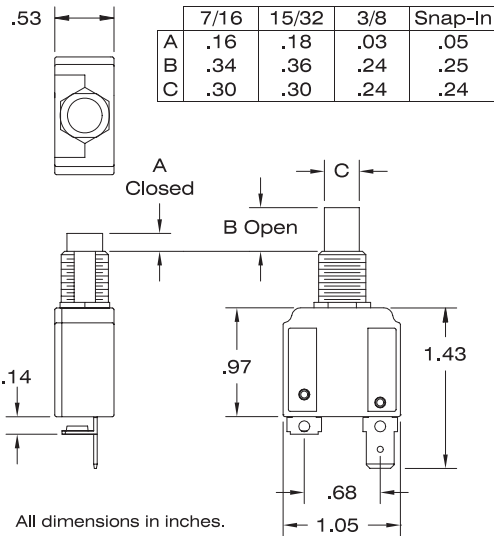

Hardware Options

(See Part Numbering Guide)

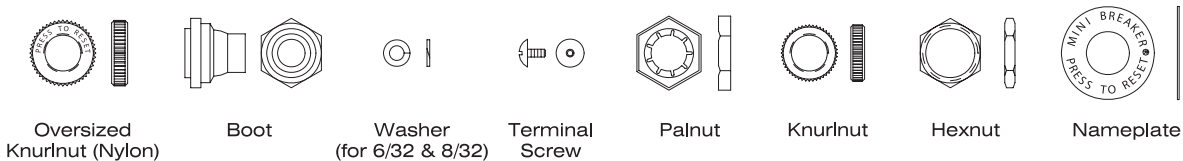

Mounting Bushing

- 0 = 7/16"-28 threaded metal, two bushing flats perpendicular to case thickness (a)
- 3 = 15/32"-32 threaded metal, shouldered, with two flats perpendicular to the case thickness (b)
- 5 = Snap-in bushing, "PRESS" mark parallel to case thickness and opposite terminals (c)
- 8 = 3/8"-27 threaded nylon, one flat parallel to case thickness and opposite terminals (d)
- 9 = 3/8"-27 threaded metal, one flat parallel to case thickness and opposite terminals (d)

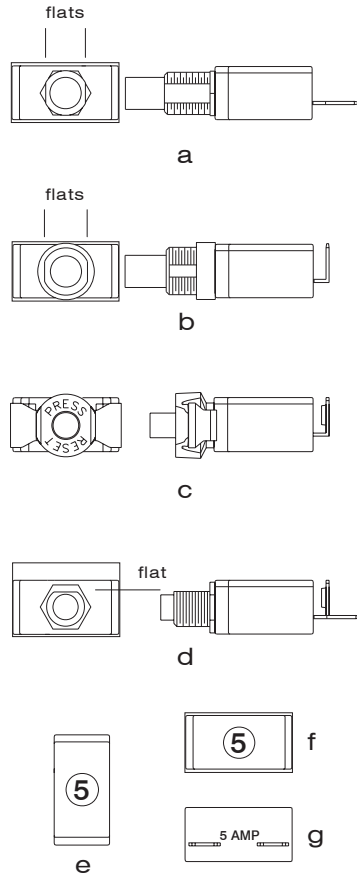

Ampere Range

0 = 3 to 20 amp, with amp stamp between terminals (g)

Button

- 0 = white — no amp stamp
- 1 = white — black parallel amp stamp (e)
- 2 = white — black perpendicular amp stamp (f)
- 3 = black — no amp stamp
- 4 = black — white parallel amp stamp (e)
- 5 = black — white perpendicular amp stamp (f)
- 6 = red — no amp stamp
- 7 = red — white parallel amp stamp (e)
- 8 = red — white perpendicular amp stamp (f)

Terminals

- 0 = Both terminals quick connect, straight (a)
- 1 = Both terminals quick connect, bent at 90° (b)
- 2 = Both terminals w/ #6-32 threads, bent at 90° (c)
- 3 = Both terminals w/ #8-32 threads, bent at 90° (c)
- 4 = One terminal quick connect straight and one terminal w/ #6-32 threads, bent at 90° (d)

Agency Approvals

- 0 = CCC
- 3 = UL/cUL/VDE/CCC (3 & 4A @ 125VAC/50VDC)
- 3 = UL/CSA/VDE/CCC (5 - 20A @ 250VAC/50VDC)



Series Number

14 = Series 14 Circuit Protector

Amp Rating

030 to 200 = 3 to 20 amps

Hardware Code (bulk packed)

- 15 = For 7/16" bushing. 1 ea. knurl nut, pal nut
- A2 = For 7/16" bushing. 1 ea. knurl nut, pal nut; 2 ea. 6-32 terminal screw, lockwasher
- C5 = For 7/16" bushing. 1 ea. knurl nut, pal nut; 2 ea. 8-32 terminal screw, lockwasher
- 13 = For 15/32" bushing. 1 ea. knurl nut, lockwasher
- 51 = For 3/8" bushing. 1 ea. knurl nut, pal nut
- A9 = For 3/8" bushing. 1 ea. black nylon knurl nut, lockwasher; 2 ea. 8-32 terminal screw, lockwasher
- E4 = For 3/8" bushing. 1 ea. knurl nut, pal nut; 2 ea. 6-32 terminal screw, lockwasher

Note: For additional hardware options, please consult factory.



Mechanical Products Company

1824 River Street Jackson, MI 49202 phone 517 | 782 | 0391 fax 517 | 788 | 6773 www.mechprod.com